

FRITZ HANSEN



VIRKELYST
PRODUCT FACT SHEET

VIRKELYST

Virkelyst is a modern outdoor series characterised by clean lines, discreet details and high comfort. Perfect for socialising and relaxing for hours in sunny gardens or terraces. Uniting beauty with resilience, the weatherproof upholstery is Oeko-Tex® certified and extremely colourfast and lightfast as well as water and dirt-repellent and mildew-resistant.

PRODUCT TYPE

Lounge chair
Sofa
Pouf
Lounge table
Table

ENVIRONMENT

Outdoor

DESIGNER

Says Who

MODELS

Seating units:
Lounge chair
2-seater sofa
3-seater sofa
Pouf

Table units:

Table (H38)
Table Small (H30)
Table High (H66)

MATERIAL

Wood: Teak (Untreated)

Cushions: Outdoor textile, Quickdry outdoor foam

The cushion range for the UK/IE is different from the main collection in order to meet local fire regulations*.

UPHOLSTERY

The following selection of textiles* is available:



MADE-TO-ORDER

N/A

CERTIFICATION

- FSC™ FSC-C120451: The wood used for Virkelyst is FSC-certified (FSC 100%) The FSC-certification ensures the wood is from responsible and environmentally managed forests that preserve the natural surroundings and support the local community.
- Oeko-Tex®: The textiles are Oeko-Tex-certified.

For more information about environment and manufacturing processes, please download our environmental information sheet at: fritzhanzen.com

TEST

Table High: EN 581-1:2006, EN 581-3:2017

SPECIFICATIONS*

Wood: New wooden, teak furniture has natural colour differences found in the freshly cut wood. Once the furniture has been exposed to the sun, these colour differences will even out. As a natural part of the aging process, the surface of teak will change when first being exposed to rain; this is the first stage of a process of wood that ages with beauty.

Textile: The textiles are Oeko-Tex-certified and extremely colour and lightfast, water and dirt-repellent and even mildew-resistant.

Cushions: The Quickdry outdoor foam provides a firm and comfortable seat that retains its shape year after year. The open-cell structure allows both water and air to pass through ensuring the cushion dries exceptionally quickly, even after a heavy downpour. Wadding is used to obtain an intended aesthetic expression and reach the optimal comfort level. Made of carded thin polyester fibres, Wadding is mainly used as a secondary filling. To ensure cushions remain beautiful over time, it is good practice to avoid them being left wet for prolonged periods, e.g., by turning them upright to let water run off or storing them in a dry environment.

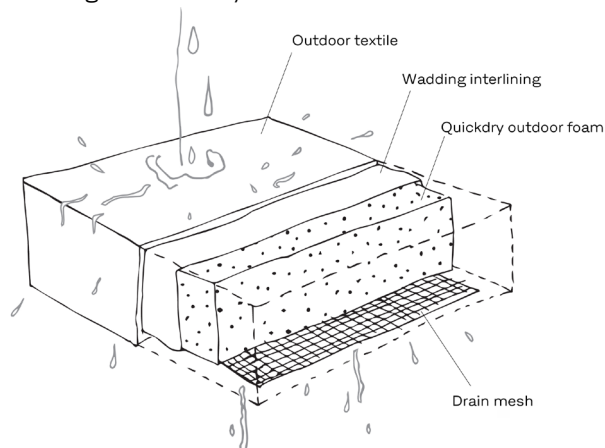

*For details specific to UK/IE go to p. 6.

WEIGHT

Chair:	23,0 kg / 50.7 lb
2-seater sofa:	32,0 kg / 70.5 lb
3-seater sofa:	36,0 kg / 79.4 lb
Pouf:	13,0 kg / 28.7 lb
Table (H38):	31,7 kg / 69.9 lb
Table Small (H30):	10,5 kg / 23.1 lb
Table High (H66):	31,7 kg / 69.9 lb

COUNTRY OF ORIGIN

Wood origin: Indonesia

Cushions: Spain

PRE-ASSEMBLED

No

PACKAGING

The units are shipped in a recycled cardboard box.

The cushions are wrapped in a plastic bag.

All packaging material can be recycled.

CLEANING AND CARE

Find recommendations for cleaning and care at:

[fritzhansen.com/maintenance](https://www.fritzhansen.com/maintenance)

REPAIR, DISPOSAL AND REUSE

In case of repair and disposal the units can be disassembled into parts. All parts can be recycled.

Check local regulations for recycling options and whether there is potential for reuse.

WARRANTY

Fritz Hansen provides a five-year warranty on standard products against defects in materials and workmanship.

Additional warranty conditions can be found at:

[fritzhansen.com/warranty](https://www.fritzhansen.com/warranty)

DIMENSIONS

POUF

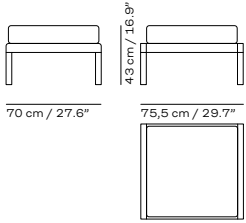

CHAIR

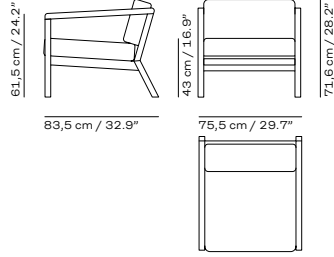

2-SEATER

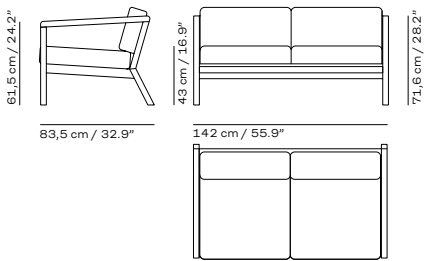

3-SEATER

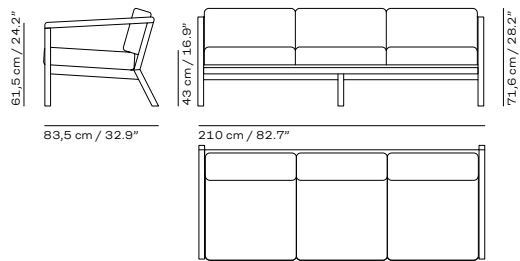

TABLE

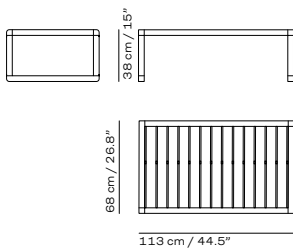

TABLE SMALL

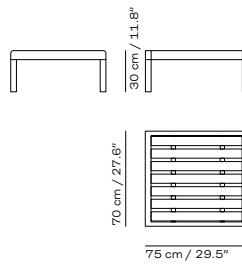
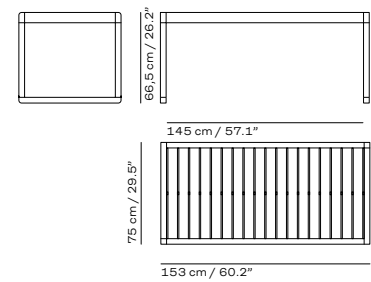

TABLE HIGH



VARIANTS*

POUF



PAPYRUS
1505899



ASH
1505791



CHARCOAL
1505792



CLOUD WHITE
1505796



HONEY YELLOW
1505797



GOLDEN YELLOW
STRIPE
1505887



SEA BLUE STRIPE
1505886

CHAIR



PAPYRUS
1505898



ASH
1505731



CHARCOAL
1505732



CLOUD WHITE
1505736



HONEY YELLOW
1505737



GOLDEN YELLOW
STRIPE
1505882



SEA BLUE STRIPE
1505884

2-SEATER SOFA



PAPYRUS
1505897



ASH
1505781



CHARCOAL
1505782



CLOUD WHITE
1505786



HONEY YELLOW
1505776



GOLDEN YELLOW
STRIPE
1505883



SEA BLUE STRIPE
1505885

3-SEATER SOFA



PAPYRUS
1505896



ASH
1505783



CHARCOAL
1505784



CLOUD WHITE
1505785



HONEY YELLOW
1505777



GOLDEN YELLOW
STRIPE
1505779



SEA BLUE STRIPE
1505778

TABLE



TEAK
S1505753



TEAK
S1505770



TEAK
1505774

*For details specific to UK/IE go to p. 6.

VARIANTS (UK/IE)

POUF



PAPYRUS
1505843



ASH
1505871



CHARCOAL
1505872



SEA BLUE STRIPE
1505891



GOLDEN YELLOW
STRIPE
1505895

CHAIR



PAPYRUS
1505842



ASH
1505851



CHARCOAL
1505852



SEA BLUE STRIPE
1505889



GOLDEN YELLOW
STRIPE
1505893

2-SEATER SOFA



PAPYRUS
1505841



ASH
1505861



CHARCOAL
1505862



SEA BLUE STRIPE
1505890



GOLDEN YELLOW
STRIPE
1505894

3-SEATER SOFA



PAPYRUS
1505840



ASH
1505863



CHARCOAL
1505864



SEA BLUE STRIPE
1505888



GOLDEN YELLOW
STRIPE
1505892

IMPORTANT NOTE!

Under current UK law, Fritz Hansen is not able to provide outdoor cushions and pillows with the same filling as the regular collection. We still offer cushions and pillows in an outdoor textile with weatherproof properties, but the filling is not weatherproof due to stringent (indoor) fire regulations. We therefore recommend that you bring cushions and pillows indoors in heavy rain and when they are not in use.

The FR cold foam provides a firm and comfortable seat that retains its shape year after year. The FR cold foam is not weather resistant, and therefore it is recommended to store the cushions indoor when not in use and during heavy downpour. To ensure cushions remain beautiful over time, it is good practice to avoid them being left wet for prolonged periods, e.g., by turning them upright to let water run off or storing them in a dry environment.