

# FRITZ HANSEN



DRACHMANN  
PRODUCT FACT SHEET

# DRACHMANN

The signature Drachmann series draws inspiration from the beautiful garden of Danish romantic poet and painter, Holger Drachmann. A careful balance of Nordic nostalgia and modern simplicity underlies its enduring popularity. Made of 100% FSC-certified teak wood selected for its strength and beauty over time, untreated teak will take on a beautiful silver-grey patina.

## PRODUCT TYPE

Armchair  
Bench  
Table

## ENVIRONMENT

Outdoor

## DESIGNER

Bernt Santesson  
Mogens Holmriis

## MODELS

Chair  
Bench 120  
Bench 165  
Bench 200  
Table Ø126  
Table 86  
Table 156  
Table 190

## MATERIAL

Teak (Untreated)

## FEATURES

- Umbrella opening (Table: Ø126, 156, 190)
- Seat cushion (Find further details on p. 6)

## MADE-TO-ORDER

N/A

## CERTIFICATION

- FSC™ FSC-C120451: The wood used for Drachmann is FSC-certified (FSC 100%). The FSC-certification ensures the wood is from responsible and environmentally managed forests that preserve the natural surroundings and support the local community.

For more information about environment and manufacturing processes, please download our environmental information sheet at: [fritzhansen.com](https://www.fritzhansen.com)

## TEST

- Chair: ANSI/BIFMA X5.4-2020
- Table Ø126: EN 581-1:2017, EN 581-3:2017, ANSI/BIFMA X5.5 2021

## SPECIFICATIONS

**Wood:** New wooden, teak furniture has natural colour differences found in the freshly cut wood. Once the furniture has been exposed to the sun, these colour differences will even out. As a natural part of the aging process, the surface of teak will change when first being exposed to rain; this is the first stage of a process of wood that ages with beauty.

## WEIGHT

Chair: 14,6 kg / 32.2 lb  
Bench 120: 22,3 kg / 49.2 lb  
Bench 165: 24,9 kg / 54.9 lb  
Bench 200: 30,4 kg / 66.9 lb  
Table Ø126: 45 kg / 99.2 lb  
Table 86: 18,9 kg / 41.6 lb  
Table 156: 28,5 kg / 62.7 lb  
Table 190: 31,8 kg / 70 lb

## COUNTRY OF ORIGIN

Wood origin: Indonesia

## PRE-ASSEMBLED

No

## PACKAGING

The units are shipped in a recycled cardboard box. All packaging material can be recycled.

## CLEANING AND CARE

Find recommendations for cleaning and care at: [fritzhansen.com/maintenance](https://www.fritzhansen.com/maintenance)

## REPAIR, DISPOSAL AND REUSE

In case of repair and disposal the units can be disassembled into parts. All parts can be recycled. Check local regulations for recycling options and whether there is potential for reuse.

## WARRANTY

Fritz Hansen provides a five-year warranty on standard products against defects in materials and workmanship.

Additional warranty conditions can be found at: [fritzhansen.com/warranty](https://www.fritzhansen.com/warranty)

### DIMENSIONS (CHAIR/BENCHES)

#### CHAIR

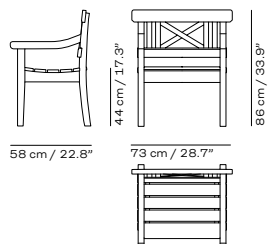

#### BENCH 120

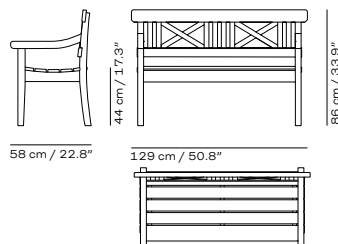

#### BENCH 165

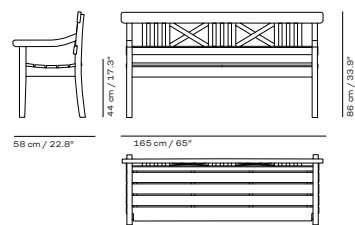

#### BENCH 200

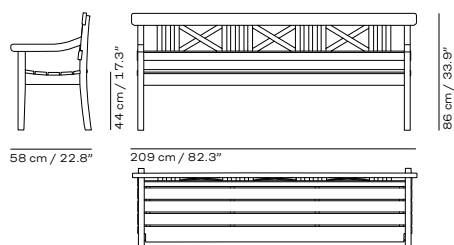

**DIMENSIONS (TABLES)**

TABLE Ø126

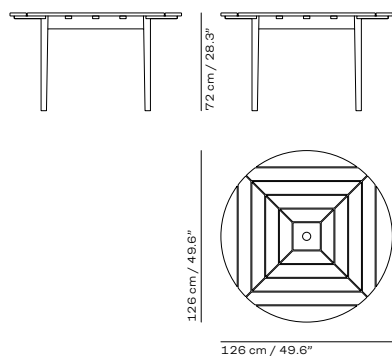

TABLE 86

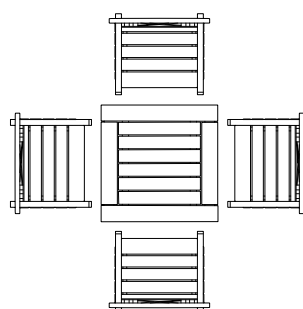
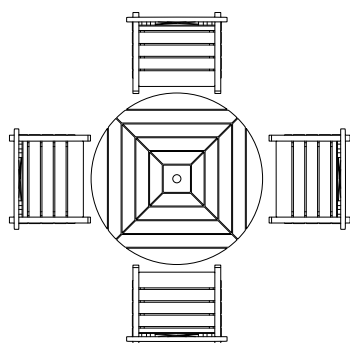
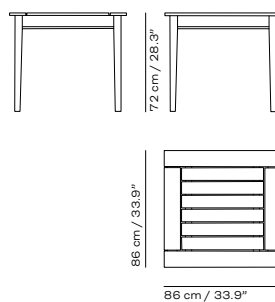

TABLE 156

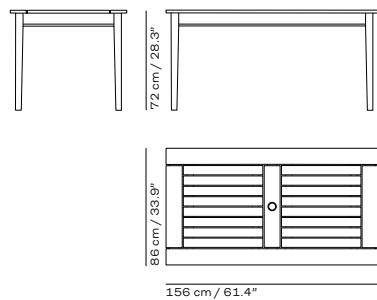
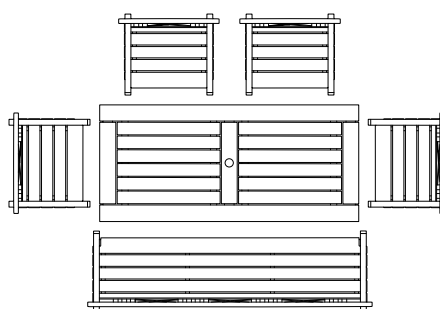
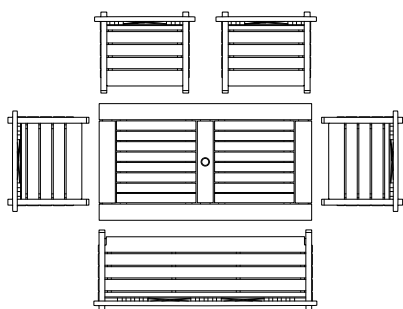
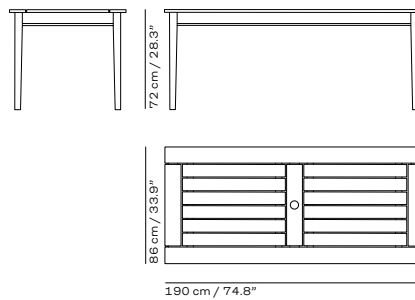

TABLE 190



**VARIANTS**

**CHAIR**



TEAK  
S1040520

**BENCH 120**



TEAK  
S1040505

**BENCH 165**



TEAK  
S1040510

**BENCH 200**



TEAK  
S1040515

**TABLE Ø126**



TEAK  
S1042005

**TABLE 86**



TEAK  
S1042010

**TABLE 156**



TEAK  
S1042015

**TABLE 190**



TEAK  
S1042020

# CUSHIONS

## DESCRIPTION

Drachmann cushions are custommade to fit the series and are highly weather-resistant. The upholstery textiles are Oeko-Tex® certified, colourfast, lightfast, water and dirt-repellent, and mildew-resistant. The cushion dries exceptionally quickly as the foam has an open-cell structure that allows water and air to pass through. The quick-dry outdoor foam provides a firm and comfortable texture that remains the same year after year.

## ENVIRONMENT

Outdoor

## DESIGNER

Skagerak Design

## MODELS

Chair Cushion  
Bench 120 Cushion  
Bench 165 Cushion  
Bench 200 Cushion

## MATERIAL

Outdoor textile  
Quickdry outdoor foam

The cushion range for the UK/IE is different from the main collection in order to meet local fire regulations\*.

## UPHOLSTERY

The following selection of textiles\* is available:

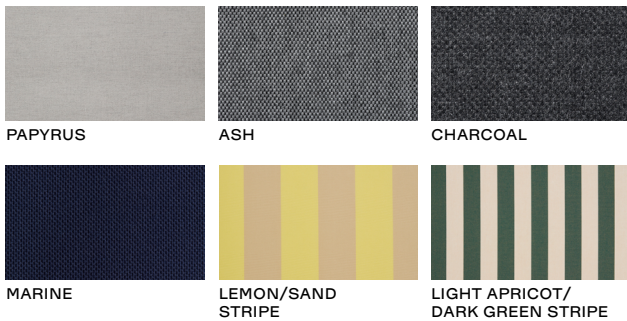

## MADE-TO-ORDER

N/A

## CERTIFICATION

Textiles: Oeko-Tex®.

For more information about environment and manufacturing processes, please download our environmental information sheet at: [fritzhanzen.com](http://fritzhanzen.com)

## TEST

N/A



## SPECIFICATIONS\*

The quickdry outdoor foam provides a firm and comfortable seat that retains its shape year after year. The open-cell structure allows both water and air to pass through ensuring the cushion dries exceptionally quickly, even after a heavy downpour. To ensure cushions remain beautiful over time, it is good practice to avoid them being left wet for prolonged periods, e.g., by turning them upright to let water run off or storing them in a dry environment.

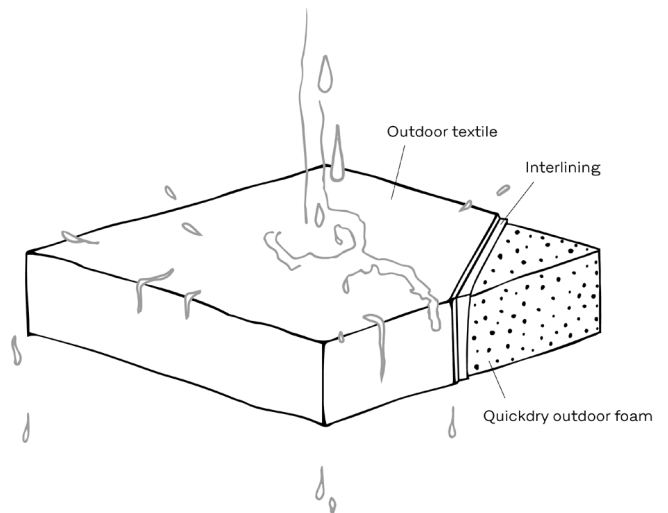

## WEIGHT

Chair Cushion: 0,9 kg / 2.0 lb  
Bench 120 Cushion: 1,6 kg / 3.5 lb  
Bench 165 Cushion: 2,2 kg / 4.7 lb  
Bench 200 Cushion: 2,7 kg / 6.0 lb

## COUNTRY OF ORIGIN

Produced in: Poland, Spain

\*For details specific to UK/IE go to p. 9.

### PRE-ASSEMBLED

Yes

### PACKAGING

The units are wrapped in a plastic bag.  
All packaging material can be recycled.

### CLEANING AND CARE

Find recommendations for cleaning and care at:  
[fritzhansen.com/maintenance](http://fritzhansen.com/maintenance)

### REPAIR, DISPOSAL AND REUSE

In case of repair and disposal the units can be disassembled into parts. All parts can be recycled. Check local regulations for recycling options and whether there is potential for reuse.

### WARRANTY

Fritz Hansen provides a five-year warranty on standard products against defects in materials and workmanship.

Additional warranty conditions can be found at:  
[fritzhansen.com/warranty](http://fritzhansen.com/warranty)

### DIMENSIONS

#### CHAIR CUSHION

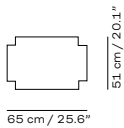

#### BENCH 120 CUSHION

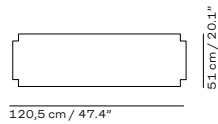

#### BENCH 165 CUSHION

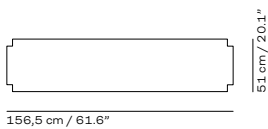

#### BENCH 200 CUSHION

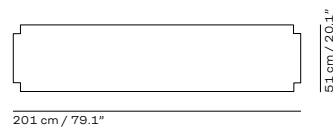

**VARIANTS\***

**CHAIR CUSHION**



LEMON/SAND STRIPE  
1960220



LIGHT APRICOT/DARK GREEN STRIPE  
1960221

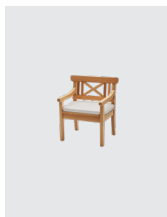

PAPYRUS  
1960228



CHARCOAL  
1960800



ASH  
1960801



MARINE  
1960803

**BENCH 120 CUSHION**



LEMON/SAND STRIPE  
1960222



LIGHT APRICOT/DARK GREEN STRIPE  
1960223



PAPYRUS  
1960229



CHARCOAL  
1960804



ASH  
1960805



MARINE  
1960807

**BENCH 165 CUSHION**



LEMON/SAND STRIPE  
1960224



LIGHT APRICOT/DARK GREEN STRIPE  
1960225



PAPYRUS  
1960230



CHARCOAL  
1960808



ASH  
1960809



MARINE  
1960811

**BENCH 200 CUSHION**



LEMON/SAND STRIPE  
1960226



LIGHT APRICOT/DARK GREEN STRIPE  
1960227



PAPYRUS  
1960231



CHARCOAL  
1960812



ASH  
1960813



MARINE  
1960815

\*For details specific to UK/IE go to p. 9.



## VARIANTS (UK/IE)

### CHAIR CUSHION



LEMON/SAND  
STRIPE  
1961090



LIGHT APRICOT/  
DARK GREEN STRIPE  
1961091

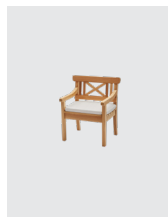

PAPYRUS  
1961199



CHARCOAL  
1960884



ASH  
1960883

### BENCH 120 CUSHION



LEMON/SAND  
STRIPE  
1961092



LIGHT APRICOT/  
DARK GREEN STRIPE  
1961093



PAPYRUS  
1961200



CHARCOAL  
1960878



ASH  
1960877

### BENCH 165 CUSHION



LEMON/SAND  
STRIPE  
1961094



LIGHT APRICOT/  
DARK GREEN STRIPE  
1961095



PAPYRUS  
1961201



CHARCOAL  
1960880



ASH  
1960879

### BENCH 200 CUSHION



LEMON/SAND  
STRIPE  
1961096



LIGHT APRICOT/  
DARK GREEN STRIPE  
1961097



PAPYRUS  
1961202



CHARCOAL  
1960882



ASH  
1960881

#### IMPORTANT NOTE!

Under current UK law, Fritz Hansen is not able to provide outdoor cushions and pillows with the same filling as the regular collection. We still offer cushions and pillows in an outdoor textile with weatherproof properties, but the filling is not weatherproof due to stringent (indoor) fire regulations. We therefore recommend that you bring cushions and pillows indoors in heavy rain and when they are not in use.

The FR cold foam provides a firm and comfortable seat that retains its shape year after year. The FR cold foam is not weather resistant, and therefore it is recommended to store the cushions indoor when not in use and during heavy downpour. To ensure cushions remain beautiful over time, it is good practice to avoid them being left wet for prolonged periods, e.g., by turning them upright to let water run off or storing them in a dry environment.