

FRITZ HANSEN



LILIUM
PRODUCT FACT SHEET

LILIUM

The Lilium collection is a contemporary take on outdoor furniture that also sits wonderfully indoors. Designed by renowned BIG – Bjarke Ingels Group – Lilium is long-lasting furniture perfect for outdoor events and gatherings.

PRODUCT TYPE

Chair/Armchair
Bench
Table
Lounge chair
Lounge table

ENVIRONMENT

Outdoor

DESIGNER

BIG - Bjarke Ingels Group

MODELS

Chair
Armchair
Bench
Lounge Chair
Table 160
Lounge Table

MATERIAL

Wood: Teak (Untreated)
Metal: Brushed stainless steel (Matt)

FEATURES

- Seat cushion (Please find further details on p. 6-9)

MADE-TO-ORDER

N/A

CERTIFICATION

- FSC™ FSC-C120451: The wood used for Lilium is FSC-certified (FSC 100%). The FSC-certification ensures the wood is from responsible and environmentally managed forests that preserve the natural surroundings and support the local community.

For more information about environment and manufacturing processes, please download our environmental information sheet at: fritzhanzen.com

TEST

Bench:

- Strenth and durability: EN 581-1: 2017, EN 581-2: 2015/AC: 2016, contract use

Chair/Armchair/Lounge Chair:

- Strenth and durability: EN 581-1: 2017, EN 581-2: 2015 + AC: 2016
- BIFMA X5.4-2020

Table/Lounge Table:

- Strenth and durability: EN 581-1: 2017, EN 581-3: 2017
- BIFMA X5.5-2014

SPECIFICATIONS

Wood: New wooden, teak furniture has natural colour differences found in the freshly cut wood. Once the furniture has been exposed to the sun, these colour differences will even out. As a natural part of the aging process, the surface of teak will change when first being exposed to rain; this is the first stage of a process of wood that ages with beauty.

Stainless steel: Stainless steel is a light weight, non-plated metal alloy with high corrosion and scratch resistance. Stainless steel is also weather resistant.

WEIGHT

Bench:	7,5 kg / 16.5 lb
Chair:	4,5 kg / 9.9 lb
Armchair:	6,4 kg / 14.1 lb
Lounge Chair:	6,5 kg / 14.3 lb
Table 160:	12,0 kg / 26.5 lb
Lounge Table:	5,5 kg / 12.1 lb

COUNTRY OF ORIGIN

Wood origin: Indonesia

PRE-ASSEMBLED

General: Yes
Table 160: No

PACKAGING

The units are shipped in a recycled cardboard box. All packaging material can be recycled.

CLEANING AND CARE

Find recommendations for cleaning and care at:
fritzhansen.com/maintenance

REPAIR, DISPOSAL AND REUSE

In case of repair and disposal the units can be disassembled into parts. All parts can be recycled. Check local regulations for recycling options and whether there is potential for reuse.

WARRANTY

Fritz Hansen provides a five-year warranty on standard products against defects in materials and workmanship.

Additional warranty conditions can be found at:
fritzhansen.com/warranty

DIMENSIONS

CHAIR

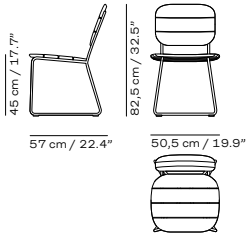

ARMCHAIR

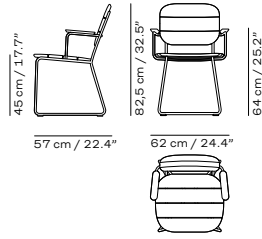

BENCH

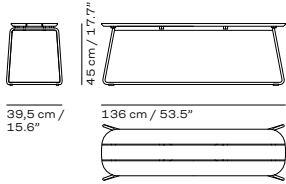

LOUNGE CHAIR

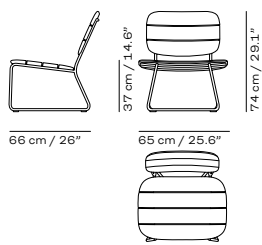
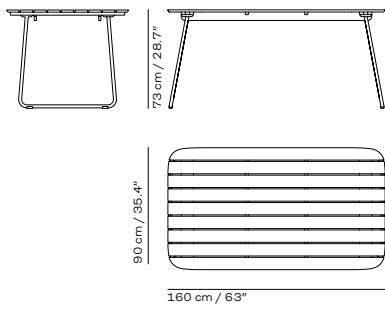
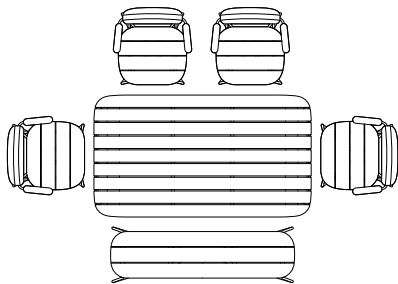
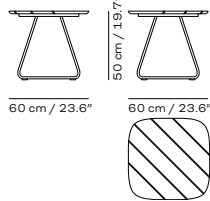

TABLE 160



LOUNGE TABLE



VARIANTS

CHAIR



TEAK
1420074

ARMCHAIR



TEAK
1420075

BENCH



TEAK
1420072

LOUNGE CHAIR



TEAK
1420070

TABLE 160



TEAK
1420073

LOUNGE TABLE



TEAK
1420071

CUSHIONS

DESCRIPTION

The Liliium series has its own cushions that are designed to perfectly fit the seat and backrest for extra softness and comfort. The cushions are made in a textile that is Oeko-Tex®-certified and extremely colourfast, lightfast, water- and dirt repellent and mildew resistant. Neoprene on the backs ensures the cushion stays in place.

ENVIRONMENT

Outdoor

DESIGNER

BIG - Bjarke Ingels Group

MODELS

Armchair/Chair Cushion
Bench Cushion
Lounge Chair Cushion

MATERIAL

Outdoor textile
Neoprene

The cushion range for the UK/IE is different from the main collection in order to meet local fire regulations*.

UPHOLSTERY

The following selection of textiles* is available:



PAPYRUS

ASH

CHARCOAL

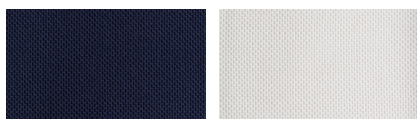

MARINE

CLOUD WHITE

MADE-TO-ORDER

N/A

CERTIFICATION

Textiles: Oeko-Tex®.

For more information about environment and manufacturing processes, please download our environmental information sheet at: [fritzhanzen.com](https://www.fritzhanzen.com)

TEST

N/A



SPECIFICATIONS*

Neoprene: Neoprene is a strong material suitable for both outdoor and indoor use. It remains firm in shape, yet flexible and soft in touch over a wide range of temperatures and humidity's.

WEIGHT

Armchair/Chair Cushion: 1,1 kg / 2.4 lb
Bench Cushion: 2,4 kg / 5.3 lb
Lounge Chair Cushion: 2,1 kg / 4.6 lb

COUNTRY OF ORIGIN

Produced in: Poland

PRE-ASSEMBLED

Yes

PACKAGING

The units are wrapped in a plastic bag.
All packaging material can be recycled.

CLEANING AND CARE

Find recommendations for cleaning and care at: [fritzhanzen.com/maintenance](https://www.fritzhanzen.com/maintenance)

REPAIR, DISPOSAL AND REUSE

In case of repair and disposal the units can be disassembled into parts. All parts can be recycled. Check local regulations for recycling options and whether there is potential for reuse.

WARRANTY

Fritz Hansen provides a five-year warranty on standard products against defects in materials and workmanship.

Additional warranty conditions can be found at: [fritzhanzen.com/warranty](https://www.fritzhanzen.com/warranty)

*For details specific to UK/IE go to p. 8.

DIMENSIONS

ARMCHAIR/CHAIR CUSHION



BENCH CUSHION

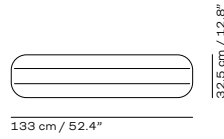

LOUNGE CHAIR CUSHION

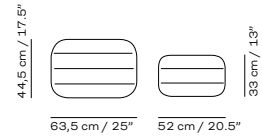

VARIANTS*

ARMCHAIR/CHAIR CUSHION



ASH
1961015



CLOUD WHITE
1961016



MARINE
1961017



CHARCOAL
1961031



PAPYRUS
1961153

BENCH CUSHION



ASH
1961019



CLOUD WHITE
1961020



MARINE
1961021



CHARCOAL
1961018



PAPYRUS
1961155

LOUNGE CHAIR CUSHION



ASH
1961012



CLOUD WHITE
1961013



MARINE
1961014



CHARCOAL
1961030



PAPYRUS
1961157

*For details specific to UK/IE go to p. 8.

VARIANTS (UK/IE)

ARMCHAIR/CHAIR CUSHION



PAPYRUS
1961210

BENCH CUSHION



PAPYRUS
1961211

LOUNGE CHAIR CUSHION



PAPYRUS
1961212

IMPORTANT NOTE!

Under current UK law, Fritz Hansen is not able to provide outdoor cushions and pillows with the same filling as the regular collection. We still offer cushions and pillows in an outdoor textile with weatherproof properties, but the filling is not weatherproof due to stringent (indoor) fire regulations. We therefore recommend that you bring cushions and pillows indoors in heavy rain and when they are not in use.

The FR cold foam provides a firm and comfortable seat that retains its shape year after year. The FR cold foam is not weather resistant, and therefore it is recommended to store the cushions indoor when not in use and during heavy downpour. To ensure cushions remain beautiful over time, it is good practice to avoid them being left wet for prolonged periods, e.g., by turning them upright to let water run off or storing them in a dry environment.